

Flat Carbon Europe



ArcelorMittal

Steel for Oil & Gas Pipes

Line Pipe, OCTG & Well Intervention



ArcelorMittal
Flat Carbon Europe

19, avenue de la Liberté
L-2930 Luxembourg

fce.technical.assistance@arcelormittal.com
www.arcelormittal.com/industry

Universal Strength in Steel



Alain Sauvan - ArcelorMittal Fos-sur-Mer

ArcelorMittal

Present in more than 60 countries and covering all major global markets (automotive, pipes, construction, household appliances, packaging etc), ArcelorMittal is a leading global force in steel operations.

The company enjoys a commanding market position, thanks to its groundbreaking R&D and technology, sizeable captive supplies of raw materials and outstanding distribution networks.

All-round respect

ArcelorMittal's primary focus is the health, safety and well-being of its employees and contractors, as well as the communities in which it operates. This firm commitment extends to the sustainable management of the environment and of finite resources, made possible through our continuous research and development of steel-based technologies and solutions that contribute, year after year, to minimising environmental impact.



ArcelorMittal Bremen

ArcelorMittal Flat Carbon Europe

Owing to our wide range of products, covering everything from commodity items to highly alloyed solutions, ArcelorMittal Flat Carbon Europe (FCE) is proud to supply design-to-purpose solutions for virtually any of your steel applications.

Partner for life

We aim to keep our customers at the heart of our operations by reducing their overall costs and developing true long-term partnerships. Our client-oriented marketing philosophy determines our strategy, approach and support with regard to the different market segments.

Premium Steel for Oil & Gas Pipes

With over 30 years' experience in producing steels for Oil & Gas welded pipes, ArcelorMittal Flat Carbon Europe supplies more than 450,000 metric tons of hot rolled steel coils each year to the global Oil & Gas Pipe industry.

Our customers form our steel strips to manufacture large-diameter pipes for hydrocarbon transportation in both sweet and sour conditions. ArcelorMittal's steels have superior properties in order to meet the most stringent strength and toughness requirements.

The success of ArcelorMittal FCE is based on the long-established expertise of highly skilled teams operating at our three mills in Bremen (Germany), Fos-sur-Mer (France) and, more recently, Krakow (Poland).

From R&D to Production and from Supply to Customer Service, our people are dedicated to meeting the needs of our Energy customers. Oil & Gas Pipe manufacturers the world over rely on ArcelorMittal FCE to provide them with premium hot rolled steel coils.

Our people are strongly committed to serving you



30 years
Steel for Oil & Gas Pipes

ArcelorMittal Bremen, Fos-sur-Mer and Global R&D Gent

Universal Strength in Steel

30 years
Steel for Oil & Gas Pipes

The **experience** and **expertise** of our **people** combined with **up-to-date** equipment are the core of what ArcelorMittal FCE has to offer.

Alain Chauvel

Every year our customers transform **450,000 metric tons** of our **steel** into API welded pipes.

Courtesy of Corinth Pipeworks (Greece)

ArcelorMittal FCE aims to strongly engage **with end users** to meet their requirements in all types of environments.

ArcelorMittal

ArcelorMittal FCE never forgets the **essence** of what it is all about.

Shutterstock - wavebreakmedia Ltd

Delivering Distinction

ArcelorMittal FCE delivers carbon steel coils to world-class Oil & Gas Pipe manufacturers on all five continents, whether the application is onshore or offshore, sweet or acid.

Our API steel product range is fully suitable for pipe forming. Depending on the processing method (ERW = Electric Resistance Welding; SAWH or SAWL = Submerged Arc Welding Helical or Longitudinal), we adjust the strip mechanical properties to match the pipe requirements (see more on page 16).

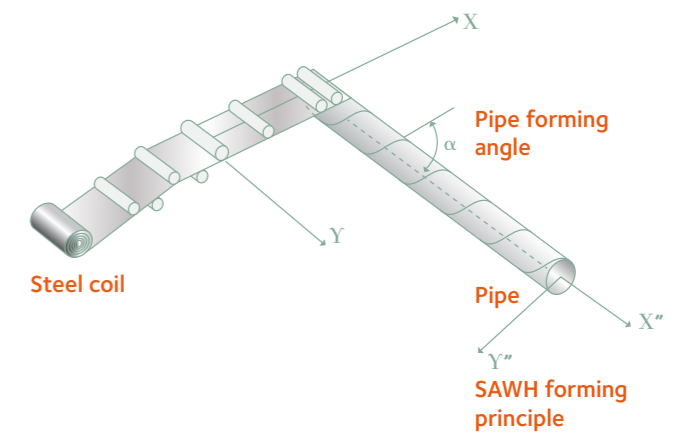

Per region
(% of metric tons delivered)

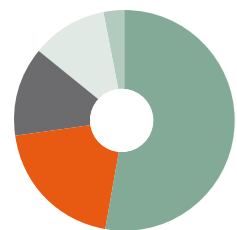

Region	%
Europe	53
Asia	20
America	13
Africa	11
Middle East	3

Per facility
(% of metric tons produced)



Facility	%
Fos-sur-Mer	58
Bremen	33
Others	9

Per thickness
(% of metric tons delivered)



Thickness (mm)	%
>20	4
14-20	40
<14	56

Per width
(% of metric tons delivered)

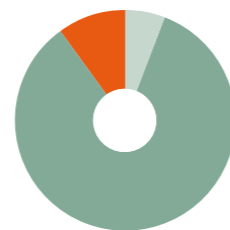

Width (mm)	%
> 1800	6
1200-1800	84
<1200	10

Per grade
(% of metric tons delivered)

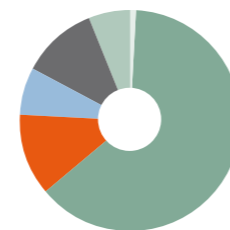

Grade	%
X80	1
X70	63
X65	12
X60	7
Softer grades	11
OCTG & Well Intervention	6
TOTAL	100

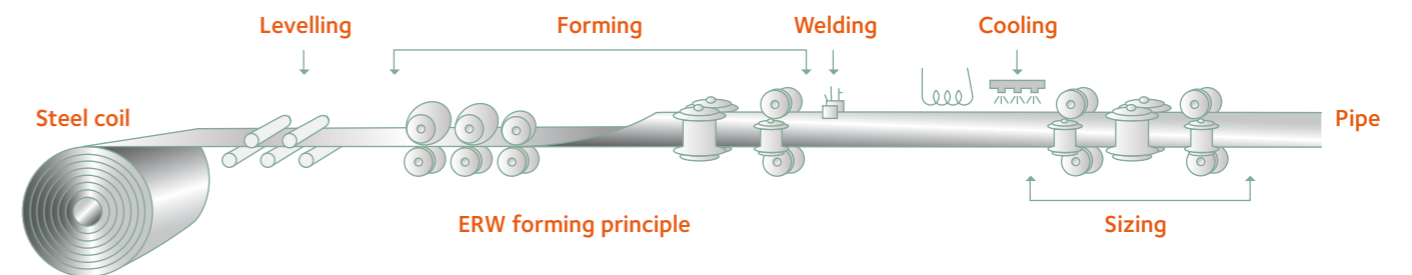

Direct sea access for fast and easy shipment solutions



Bremen and Fos-sur-Mer enjoy direct sea access, adjacent to the mills. This provides fast and easy shipment options whilst ensuring reliability to deliver regular and large quantities.



Courtesy of SCC Nigeria



Courtesy of Corinth Pipeworks

SAWH (left) and ERW (right) welding heads overview

30 years
Steel for Oil & Gas Pipes

Presenting our Steel for Oil & Gas families

The Oil & Gas welded pipe industry requires a large variety of steels to accommodate the most severe

conditions. Depending on the final application we offer three steel product families.

Line Pipe (API 5L, ISO 3183, EN 10208-2)

For pipeline transportation systems

Black Hot Rolled Steel Coils and Sheets
Sweet and sour service
Any standard can be considered

API 5L: Grade B to X80 (PSL1 and PSL2)
ISO 3183: Grade B to X80
EN 10208-2: L245MB to L555MB



SAWH API 5L pipes being inspected during the coating operation.

OCTG (API 5CT)

A wide range of J55 grades, from low to high carbon levels

API 5ST, A 606-T4, AISI 4130

20 years' experience of Well Intervention products

Black or Pickled & Oiled Hot Rolled Steel Coils

Pickled & Oiled Hot or Cold Rolled Steel Coils



Drilling rig in the Eagle Ford shale play (Southern Texas)



Pickled and oiled coils ready for overseas shipment (Fos-sur-Mer)

High quality products High value for our customers

Extensive Steel Product Range for API Pipes

High strength grades

- Up to X80M-PSL2

Heavy thicknesses

- Up to 25.4 mm

Excellent toughness properties

- CVN and DWTT at low temperature

Heavy coils

- Up to 45 t

Large widths

- Up to 2146 mm

Speciality products

- HIC-resistant grades for Sour service
- OCTG and Well Intervention grades
- Cut-to-length sheets

Large and reliable capacity

- Heavy-duty equipment
- 3 production facilities
- Regular dedicated investments
- Consistent quality and mechanical properties to secure medium and large-scale projects



Courtesy of Corinth Pipeworks (Greece)

Tailored offering

Complex projects often have requirements over and above the standard. Furthermore, the characteristics of steel strips need to be adjusted to compensate for the change in mechanical properties between the as-delivered coil and the manufactured pipe (greatly influenced by the type of forming, the grade and the dimensions).

Our make-to-order strategy ensures that we meet our clients' unique needs. Projects are only defined once a technical study of the client specification has been conducted for each steel grade x dimension x volume. The tables below give an indicative overview of our product range and dimensional feasibility.

Hot Rolled Steel Coils for Line Pipe applications (API 5L, ISO 3183, EN 10208-2)

Welding processes: SAWH, SAWL, ERW

Steel grade		Width (mm)		Max thickness (mm)		
API 5L ISO 3183	EN 10208-2	min	max	no DWTT	DWTT -10°C / 85%	Sour service (1)
X80	L555	850	2146	25.4	22	n.a.
X70	L485	850	2146	25.4	23	13
X65	L450	850	2146	25.4	20	16
X60	L415	850	2146	25.4	20	16
X52	L360	850	2146	25.4	20	16
X42	L290	850	2146	25.4	20	16

We also supply cut-to-length sheets: please contact us.

Hot Rolled Steel Coils for welded Casing and Tubing Pipes (API 5CT)

Welding process: ERW

Steel grade	Thickness (mm)	%C
J55	1.6 - 16	≤ 0.17
J55 N	1.6 - 16	≤ 0.21
N80 - P110	2.2 - 16	≤ 0.26
L80	2.2 - 18	≤ 0.43
K55 (in development)	2.2 - 16	≤ 0.36

For higher carbon versions up to %C = 0.48: please contact us.

Hot Rolled Steel Coils for Well Intervention Pipes

Welding process: ERW

Standard	Thickness (mm)	Sour service	YS on pipe (ksi)
API 5ST	1.6 - 7	YES	55 to 120 min
A 606-T4	1.6 - 7	-	-
AISI 4130	on request	-	-

(1) Fos-sur-Mer only; HIC-resistant according to NACE TM0284:2003 solution A (pH=2.7)

In addition to our grades dedicated to the Oil & Gas industry, we deliver steel coils for the manufacture of water or slurry transportation pipes, as well as civil engineering solutions (piling pipes).



Alain Chauvet, ArcelorMittal, Fos-sur-Mer

The extreme rolling speeds (up to 1200 m/min) require a combination of precise automatic control and human expertise

30 years
Steel for Oil & Gas Pipes

You deserve
premium steel

It all starts with
premium slabs...

Good steel starts with good slabs. ArcelorMittal's steels for Oil & Gas Pipes are manufactured using advanced metallurgical processes to meet both sweet and sour service requirements through a design-to-purpose approach.

The process is constantly monitored and controlled via a supervision system that is independent of production. Cross-section characterisation tests of the full slab are performed by macro-etching to ensure a low level of central segregation.

The slabs are reheated and thermomechanically rolled with accelerated cooling to achieve the required thickness and homogeneous mechanical properties. ArcelorMittal's steels have a fine and homogeneous microstructure, which ensures an optimised combination of strength and toughness.



Slab oxycutting at Fos-sur-Mer

Alain Sauvan



Slab being loaded from the continuous casting exit table after final water spray cooling (Fos-sur-Mer)

Alain Chauvet

30 years
Steel for Oil & Gas Pipes



Alain Sauvan - ArcelorMittal Fos-sur-Mer, downcoiler

Facilities Bremen, Fos-sur-Mer and Krakow

Manufacturing both Oil & Gas and automotive products at the same mills requires us to continually monitor and challenge our quality performance.

Our 30 years of experience in the Oil & Gas industry is another key element in the quality and reliability of our deliveries. To ensure a secure supply, we aim to approve two of our facilities to produce large volumes to the same specification.

Whether handling a one-off steel batch or the manufacture of several thousand metric tons of steel in just a few months, ArcelorMittal FCE aims to ensure that product properties remain consistently reliable.

By knowing the capabilities of our equipment and constantly acquiring new technical expertise, we can guarantee to supply you with the right product.

3 facilities in Europe

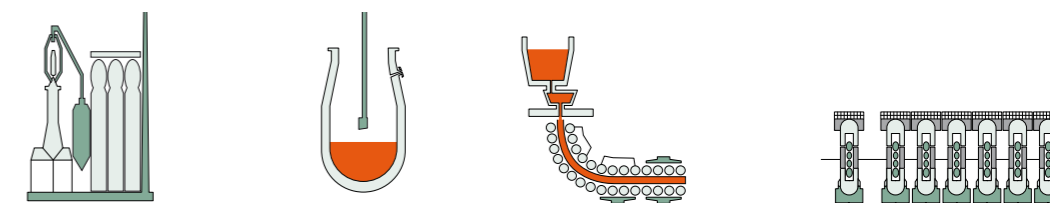

	Blast Furnace	Steel shop	Continuous Caster	Thermomechanical hot rolling mill
Bremen	2 x BF	2 x LD (290 t) RH degasser	1 x CC x 2 strands Vertical-curved	HSM 78.7" 1" DC installed in 2009 3" crop shear installed in 2011
Fos-sur-Mer	2 x BF	2 x LET (340 t) RH degasser STAD CAS-OB	2 x CC x 2 strands Vertical-curved CC#1 Relined in 2007	HSM 84.5" 1" DC installed in 2008
Krakow	2 x BF	2 x LET (340 t) 2 x LF	1 x CC - SR Vertical-curved	HSM 80.3" 1" DC installed in 2007

BF: Blast Furnace
LET: Bottom Stirring
LD: Linz-Donawitz
STAD: Desulphurisation Station
CAS-OB: Argon Sealed atmosphere
LF: Ladle Furnace

RH degasser: vacuum circulation degasser
CC: Continuous Caster
SR: Soft Reduction
HSM: Hot Strip Mill
DC: Downcoiler

Our Steel-making Process Step by Step

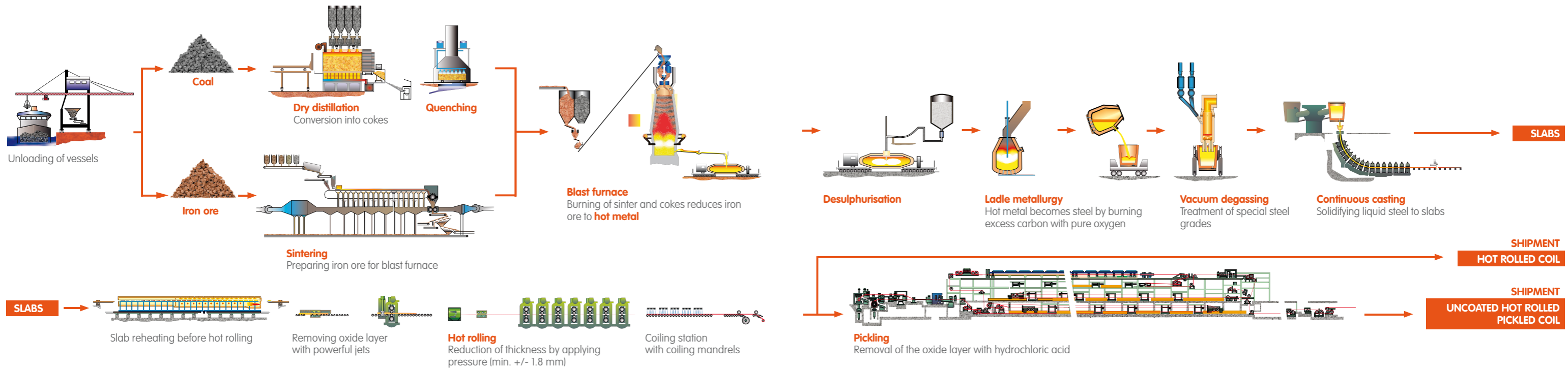

Converter and ladle metallurgy

From iron ore and coke selection to ladle metallurgy, we aim to fine-tune the final steel chemistry to ensure the soundness and mechanical properties of the final material. We particularly focus on ensuring an extra low phosphorous and sulphur content (below 20 ppm), while implementing calcium treatment to minimise the formation of harmful inclusions.

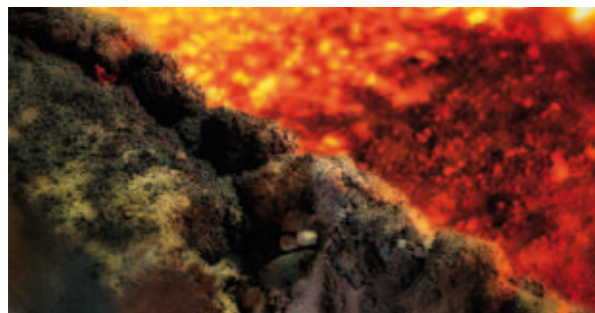

Alain Sauvann

Continuous casting

The recently relined continuous casters are vertical-curved to ensure better inclusion decantation. They are also equipped with divided rolls to prevent bulging. Combined with a tundish flow control system, this greatly contributes to minimising central segregation, while full slab cross-section macro-etching is regularly performed as a standard control procedure.



Alain Chauvel

Hot rolling

After reheating, the slabs are thermomechanically rolled to reach the required thickness and homogeneous mechanical properties. The aim is to achieve the targeted grain refinement (consistently finer than 8). This ensures an optimised combination of strength and toughness.

Powerful and sophisticated run-out tables make it possible to process everything from dual or multiphase thin steels for automotive applications to thick API steels. At Fos-sur-Mer, the abundant water flow reaches 400 m³/minute.

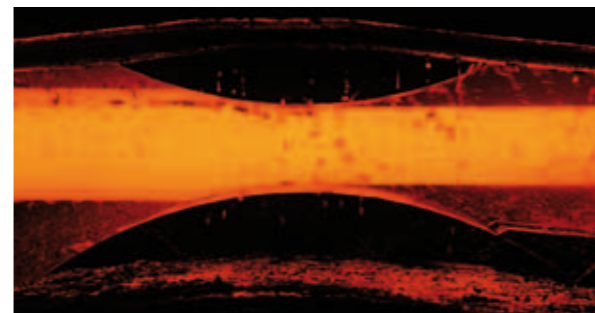

Alain Chauvel

In 2011 the Bremen mill unveiled the world's biggest crop shear. Capable of shearing up to 76 mm thick transfer bars prior to finish rolling, this new piece of equipment enables the production of strips of greater thickness with improved toughness. This also opens up the possibility of creating innovative steel properties.



BUtech Bliss

Meet your requirements for pipe mechanical properties

Steel strips are delivered with extra strength to compensate for the apparent loss in yield strength between the as-delivered steel coil and the manufactured pipe. The extent of this loss is

greatly influenced by the type of forming (SAWH, SAWL, ERW), the grade and the dimensions. In the case of smaller diameters (usually ERW), the yield strength will actually increase on pipe.

Our process

Steel mechanical properties are obtained by a combination of chemistry and hot rolling parameters.

The water flow on the finishing stands (hot rolling mill) must remain laminar to ensure premium homogeneity of the mechanical properties. The shape of the nozzles is specifically designed to ensure uniform cooling.

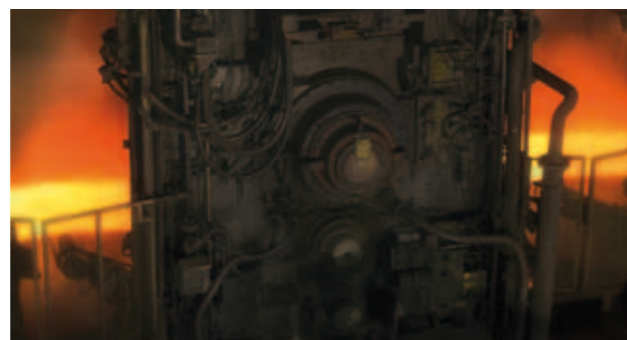

Alain Sauvann

Our steel Mechanical Properties Prediction

To anticipate the drop in yield strength on large OD pipes, we have created a database and software that predict the mechanical properties on pipe, based on the dimensions and values on strip.

Our aim is therefore to ensure that our customers can reliably use our product and deliver to end users within the required project time frame. This also makes it possible to offer a cost-effective design-to-purpose package.

Comparison of the yield strength distribution on a 48" SAWH pipe (thickness = 13 mm) in X70M-PSL2 versus the initial strip properties. This enables the required mechanical properties on strip to be refined in order to meet pipe requirements.

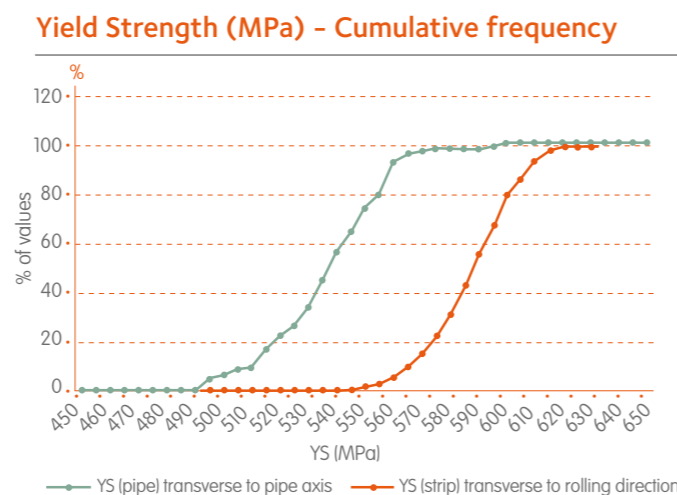

Meet your most stringent toughness requirements on heavy walls

Achieving stringent toughness properties on high strength heavy wall strips is critical, since this is directly related to grain size and microstructure homogeneity throughout the thickness of the sheet. Dedicated low carbon chemistry, combined with finely tuned cooling during the hot rolling process, is mandatory.

Above 22 mm gauge, the final strip wall becomes too thick compared with the transfer bar thickness prior to finish rolling. In 2011 ArcelorMittal Bremen installed the world's biggest crop shear, capable of cutting 76 mm thick bars.

Our process

Thermomechanically hot rolled steel. High reduction ratios combined with finely tuned cooling and dedicated chemistry.

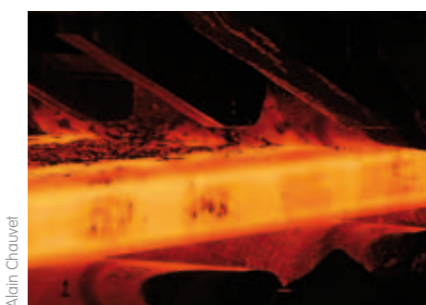

Alain Chauvel

Hot rolling mill at Fos-sur-Mer

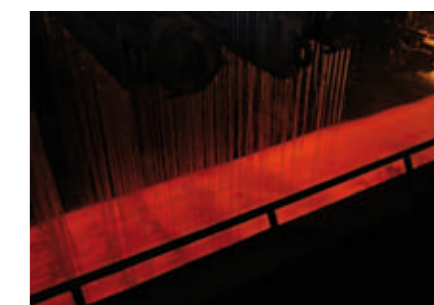

Alain Chauvel

Our steel Fine grain microstructure, even on high strength & heavy wall strips

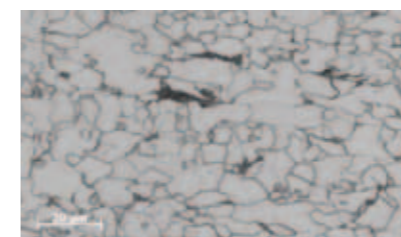

1 - NON API: for reference S355MC construction steel Optical micrography



2 - X80M-PSL2 Thickness = 23.7 mm Optical micrography

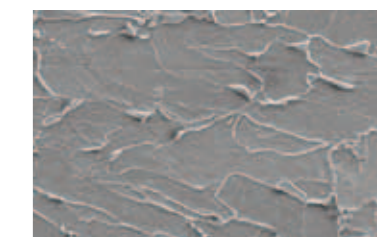

3 - X80M-PSL2 Thickness = 23.7 mm SEM image (same position as 2)

Your product Meeting the API strength requirements

Hydrotest on SAWH pipes. Making sure the minimum mechanical properties are achieved on the formed pipe is mandatory to comply with the pressure requirements.

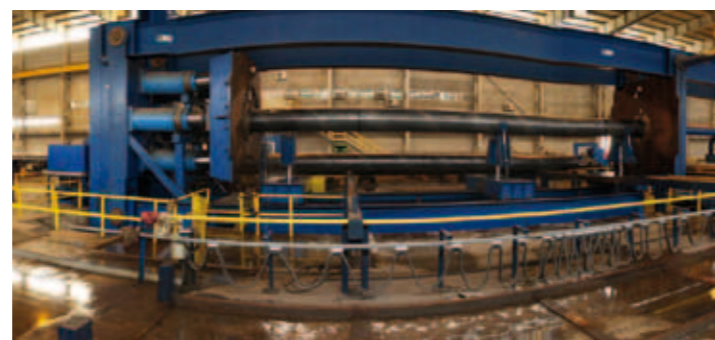

Courtesy of SCC Nigeria

Your product Premium toughness properties

CVN impact test on X70M-PSL2 (transverse direction on coil)

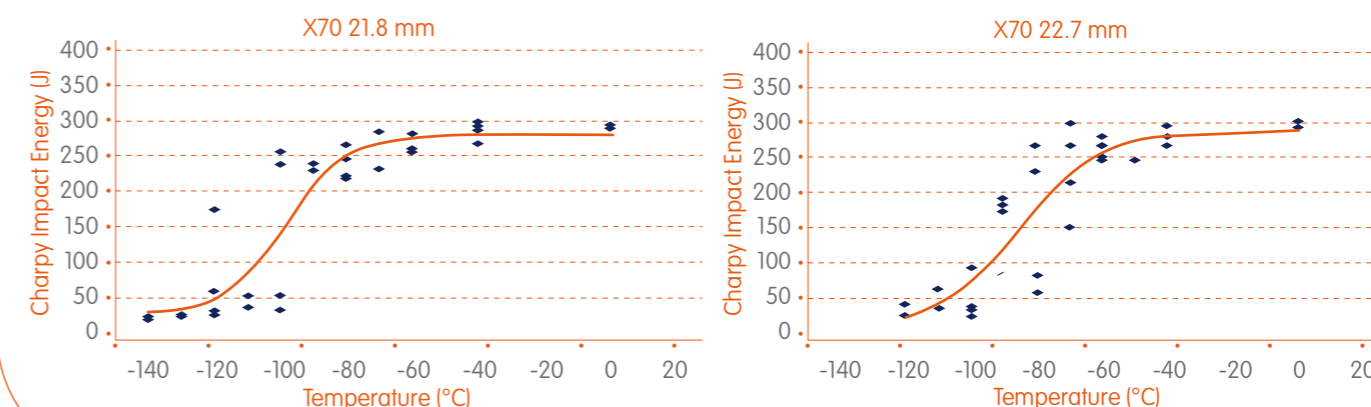

30 years
Steel for Oil & Gas Pipes

Meet your sour and acid requirements

The presence of H_2S in Oil & Gas environments exposes steel to various forms of corrosion cracking. Hydrogen-Induced Cracking (HIC) and Sulphide Stress Corrosion Cracking (SSCC) are initiated at microscopic trap sites. It is therefore essential to reduce impurities. In this regard, the sulphur content has to be

kept low and the microstructure must be extremely homogeneous, since any hard point or void would be a source of hydrogen embrittlement. Recent projects have also benefited from the use of HIC-resistant steels for CO_2 transportation.

Our process

HIC-resistant steel would not exist without the appropriate chemistry (low sulphur and phosphorus content and inclusion shape control by calcium treatment to reduce MnS precipitation). In addition, the casting and hot rolling parameters must be carefully designed and monitored.

We benefit from the following equipment and practices:

- Vacuum degassing to reduce the gas content of steel
- Vertical-curved continuous casters with divided rolls
- Finely tuned thermomechanical rolling parameters to guarantee the absence of hard spots
- Coiling temperature monitoring



Low sulphur and phosphorus content in liquid steel is the initial requirement for sour and acid serviceability of the final pipe. We guarantee a maximum of 20 ppm of sulphur, and generally achieve half of this value.

Alain Sauvan

Our steel

By monitoring the successive process steps, we can offer a fine grain microstructure with a minimised banded pattern.

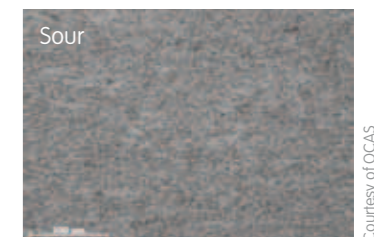

Courtesy of OCAS

Sour and Acid Service

Microstructure of non-sour steel (X65M-PSL2) versus HIC-resistant steel (X65MS-PSL2). Thickness = 10 mm.

Your product

We guarantee HIC resistance as per NACE TM0284 Solution A pH = 2.7 in our integrated testing laboratory at Fos-sur-Mer. SSCC and CO_2 testing are also available.



The samples are placed in the H_2S rig for 96 hours.

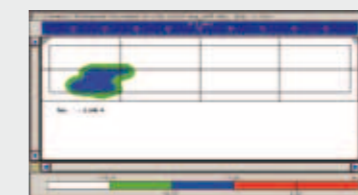

The samples are UT inspected to make sure no cracks are missed.

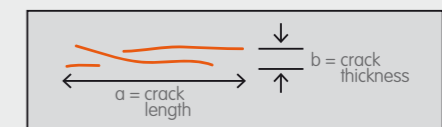

If a crack is found, the sensitivity (CSR), length (CLR) and thickness (CTR) ratios are calculated.

You deserve premium support

Gent (Belgium) OCAS R&D Centre



We are there for you...

... no matter where you are.

Our multicultural technical team stays in close contact with the process and logistics teams at our mills to ensure the required end results. Just as important, they are ready to discuss and address your needs and concerns at any time, supporting you on your site whenever necessary and wherever you are in the world.

Safety comes first (Bremen and Fos-sur-Mer are OHSAS-certified).

Quality is our mindset.

Confidentiality is our daily concern.

Mutual understanding and regular direct communication are the baseline for optimum technical collaboration.

These four principles are the core values of ArcelorMittal Flat Carbon Europe.

OCAS is a joint venture between ArcelorMittal and the Flemish Region. With more than 140 engineers and technicians from 16 countries, the R&D lab develops new steel grades and steel processing solutions.

The main focus of its research activities is supporting the Oil & Gas Pipe market.

By developing heavy-gauge line pipe steels and OCTG grades:

- with higher strength;
- with improved toughness at low temperature;
- with sour corrosion resistance (HIC, SSCC).

By providing technical support for Oil & Gas customers:

- welding (SAW, HFI, girth welding);
- corrosion in sweet and sour environments;
- fracture mechanics and toughness (CTOD, BDWTT etc);
- numerical modelling (properties of structures);
- failure and damage analysis.

Our dedicated API pipe team and state-of-the-art equipment are now brought together at the Metal Structures Centre, located in Ghent.

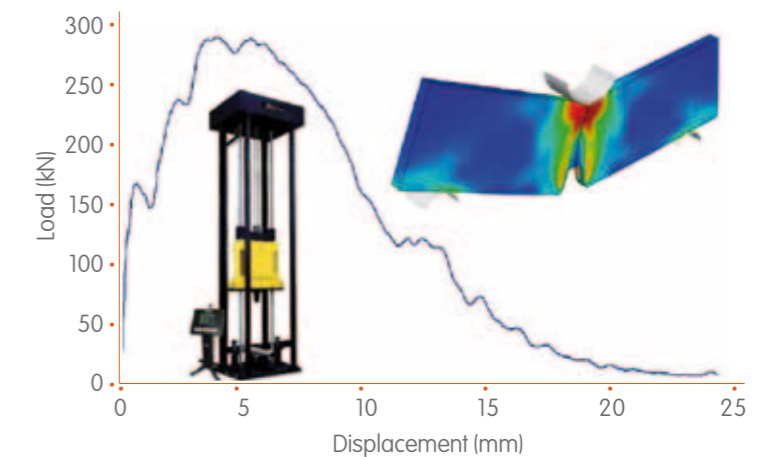

BDWTT testing and modelling. OCAS has the ability to measure the energy level effectively reached during testing.

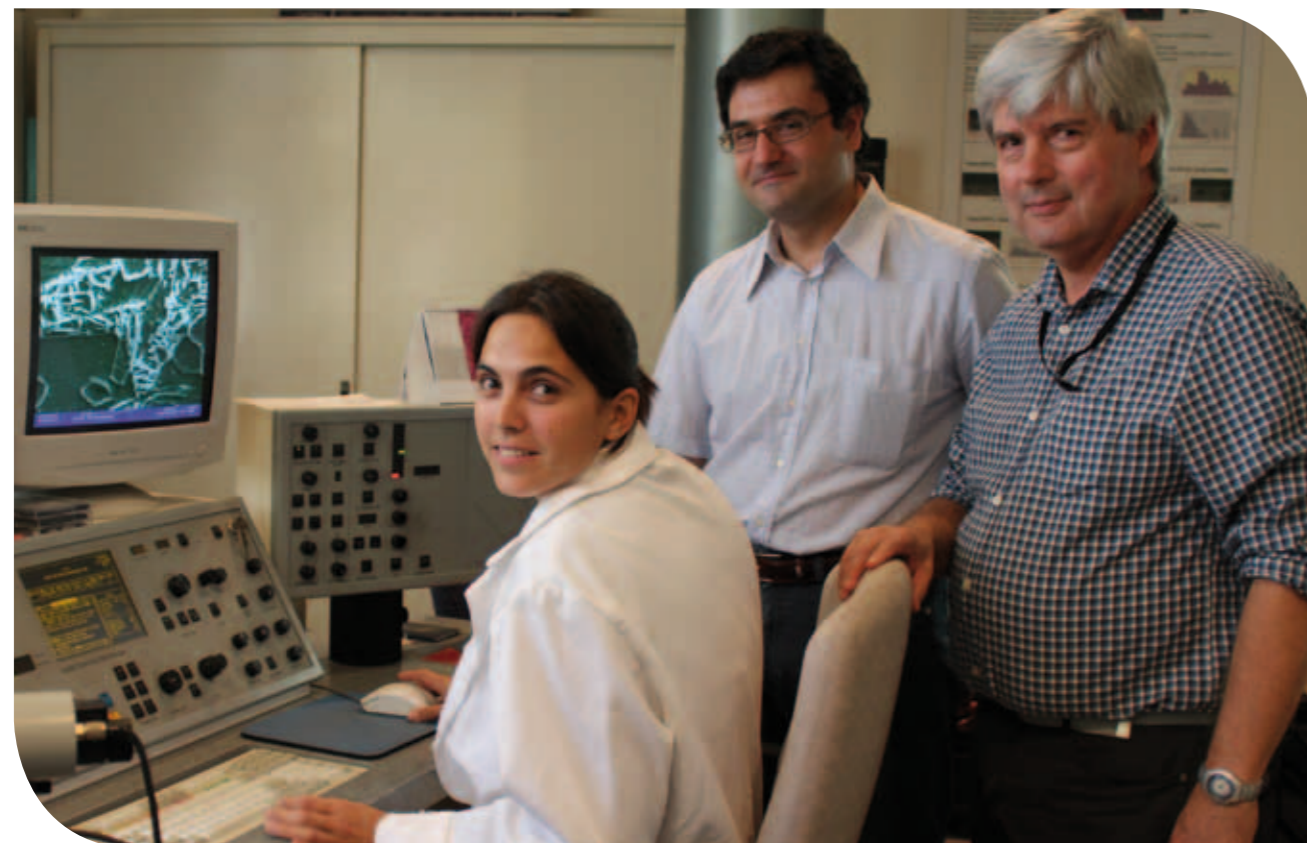

Alain Chauvel - ArcelorMittal Fos-sur-Mer



Courtesy of OCAS

Hot Rolling trial on a new grade being developed at OCAS. The laboratory has the ability to reproduce the thermomechanical process on small-scale steel slabs.



Recently (2011) installed SAW equipment in Zwijnaarde (Ghent)

You deserve premium technical support

Your certified partner

We are always ready to assist with any questions regarding Steel for Oil & Gas Pipes and are open to collaborative partnerships with our customers to find unique solutions. Over the past 30 years, ArcelorMittal FCE has built up an Oil & Gas centre of excellence, staffed

by metallurgists, welding technicians and engineers, most of whom have recognised skills in tubular applications. Our specialised team can provide detailed feasibility studies for specific projects as well as technical support on any pipe-related issues.

Example 1 - New design-to-purpose steel for CO₂ transportation

ArcelorMittal Flat Carbon Europe supplied the steel used for the Denbury-Greencore project in the USA. This 232 mile long pipeline is designed to transport CO₂ for enhanced oil recovery projects. CO₂ becomes extremely corrosive in the presence of water or impurities. As a consequence, several CO₂

transportation pipeline projects are now requiring acid-resistant steel. Fos-sur-Mer supplied 58 kt of HR steel coils (X70MS-PSL2) to Corinth Pipeworks (Greece), which manufactured the 20" OD pipes using high frequency electric resistance welding. Every single casting complied with the NACE TM0284 A requirement, with great consistency.

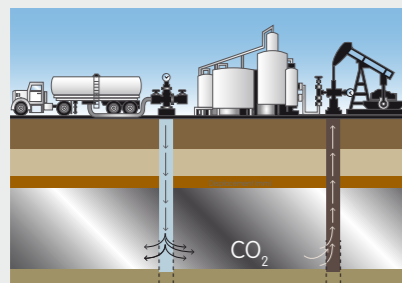

Principles of CO₂ reinjection for oilfield revival applications.

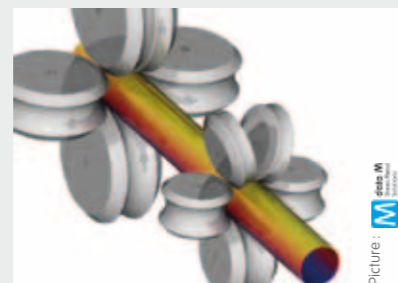

Greencore HFW pipes comply with acid environment requirements. Above is a 3D overview of the forming principle.

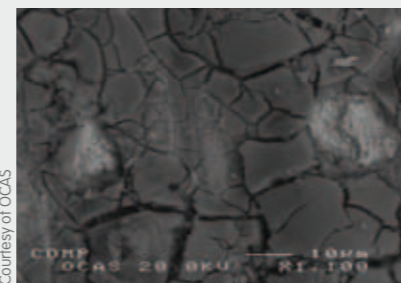

Steel surface after carbonic acid attack.

Example 2 - Heat Affected Zone Analysis (HFW)

We analysed the weld of a 14 mm thick HFW pipe (X65M-PSL2) to evaluate the grain size and orientation of the bond line (BL), located in the

middle of the weld profile. The weld microstructure was then correlated with the toughness of the BL.



Overview of the weld after Nital etching, prior to heat treatment.

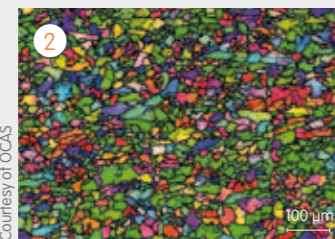

Grain orientation in the base metal (fine microstructure with no preferred grain orientation).



Grain orientation in the BL (coarse microstructure with preferred grain orientation) before post-welding heat treatment.

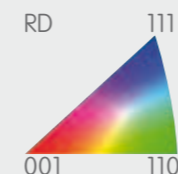

{111}, {110}, and {001} poles showing the grain orientation versus the rolling direction (RD).

Although the hardness variations are not necessarily correlated with the toughness properties, the results confirmed that the grain orientation would be a more determinant factor. The less the grains are oriented in a single preferred direction, the better the toughness. The study showed that the grain orientation tends to go back to a more mixed pattern (with less preferred orientation) after the post-welding heat treatment, thus offering higher ductility than the case shown in picture 3.

References: • Yan P., Güngör Ö. E., Thibaux P., Liebeherr M., Bhadeshia H. K. D. H., Tackling the toughness of steel pipes produced by high frequency induction welding and heat treatment, Materials Science and Engineering: A, Vol. 528, No. 29-30 (2011), pp. 8492-8499.

Bremen and Fos-sur-Mer are ISO TS 16949, ISO 14001, ISO 9001 and OHSAS 18001 certified

Going greener

Steel and the term 'environmentally friendly' may not seem to go hand in hand. However, we are fully committed to reducing each year the impact that our steel manufacturing activities have on the environment.

Facts

- ISO 14001 certification of our three plants.
- 50% of the Fos-sur-Mer site is dedicated as green space.
- Daily efforts to produce the finest steel possible, resulting in a greatly reduced sensitivity to atmospheric, sour and acid corrosion compared with commodity steel, which in turn has a positive impact on human and environmental safety during final product usage.



ArcelorMittal



ISO/TS 16949 (Fos-sur-Mer) ISO 14001 (Fos-sur-Mer)



ISO 9001 (Fos-sur-Mer) OHSAS 18001 (Fos-sur-Mer)



ISO/TS 16949 (Bremen) ISO 14001 (Bremen)



ISO 9001 (Bremen) OHSAS 18001 (Bremen)

They used our steel

Examples of projects

Global Presence

Keystone XL oil pipeline (36")

- Country: USA and Canada
- End user: Transcanada
- Customer: Welspun LR (USA)
- Pipe processing: SAWH
- Grade: APIX70M-PSL2
- Dimensions: 1800 x 11.8 and 13.1 mm
- Total volume: 87 kt
- Production plant: Bremen
- Deliveries: 2010-2011

Algonquin gas system pipeline (36")

- Country: USA
- End user: Spectra Energy, TX
- Customer: Corinth Pipeworks (Greece)
- Pipe processing: SAWH
- Grade: APIX70MS-PSL2
- Dimensions: 1800 x 19.1 mm
- Total volume: 15 kt
- Production plant: Bremen
- Deliveries: 2008

Greencore CO₂ pipeline (20")

- Country: USA
- End user: Denbury Resources Inc.
- Customer: Corinth Pipeworks (Greece)
- Pipe processing: HFW
- Grade: APIX70MS-PSL2 (sour service)
- Dimensions: 1598 x 11.2 mm
- Total volume: 58 kt
- Production plant: Fos-sur-Mer
- Deliveries: 2010-2011

Haynesville-Acadian gas pipeline (36" and 42")

- Country: USA
- End user: Enterprise Products Partners L.P.
- Customer: Welspun Anjar (India)
- Pipe processing: SAWH
- Grade: APIX70-PSL2
- Dimensions: 1700 x 13.08 and 13.23 mm
- Total volume: 30 kt
- Production plant: Fos-sur-Mer
- Deliveries: 2010

Tennessee Gas Pipeline 300 Line Expansion (36")

- Country: USA
- End user: El Paso, USA
- Customer: Borusan Mannesmann (Turkey)
- Pipe processing: SAWH
- Grade: APIX70-PSL2
- Dimensions: 1500 x 8.86 mm
- Total volume: 18 kt
- Production plant: Fos-sur-Mer
- Deliveries: 2009

RWE Breagh offshore gas pipeline (20")

- Country: UK
- End user: RWE Dea UK
- Customer: Corinth Pipeworks (Greece)
- Pipe processing: HFW
- Grade: APIX65-PSL2
- Dimensions: 1574 x 19.1 mm
- Total volume: 24 kt
- Production plant: Fos-sur-Mer
- Deliveries: 2010-2011

Sabah Sarawak gas pipeline (36")

- Country: Malaysia
- End user: Petronas, Malaysia
- Customer: Mitco, Japan
- Pipe processing: SAWH
- Pipe manufacturer: Petropipe Sabah (Hicom group)
- Grade: APIX70-PSL2
- Dimensions: 1800 x 16.27 & 14.23 mm
- Total volume: 36 kt (Fos-sur-Mer) and 144 kt (Bremen)
- Production plant: Fos-sur-Mer, Bremen
- Deliveries: 2008-2009

Al Ulqiah Block S2 pipeline (16")

- Country: Yemen
- End user: OMV Exploration
- Customer: Corinth Pipeworks (Greece)
- Pipe processing: HFW
- Grade: APIX60-PSL2
- Dimensions: 1282 x 9.53 mm
- Total volume: 13 kt
- Production plant: Fos-sur-Mer
- Deliveries: 2010

Shaybah ARAMCO sour service pipeline (30")

- Country: Kingdom of Saudi Arabia
- End user: Saudi ARAMCO
- Customer: National Pipe Company
- Pipe processing: SAWH
- Grade: APIX65-PSL2
- Dimensions: 1520 x 11.1 & 13.8 mm
- Total volume: 35 kt
- Production plant: Fos-sur-Mer
- Deliveries: 2008

SCOP Crude oil pipeline (24")

- Country: Iraq
- End user: SCOP
- Customer: MAN Industries (India)
- Pipe processing: SAWL
- Grade: APIX60-PSL2
- Dimensions: 1865 x 11.1 mm
- Total volume: 10 kt
- Production plant: Bremen
- Deliveries: 2010

GK3 Hassi R'Mel – Skikda pipeline (48")

- Country: Algeria
- End user: Sonatrach, Algeria
- Customer: Alfapipe, Algeria
- Pipe processing: SAWH
- Grade: APIX70-PSL2
- Dimensions: 1800 x 14.7 mm
- Total volume: 94 kt (Fos-sur-Mer)+ 6 kt (Bremen)
- Production plant: Fos-sur-Mer, Bremen
- Deliveries: 2008-2009

GR4 pipeline (48")

- Country: Algeria
- End user: Sonatrach, Algeria
- Customer: Alfapipe, Algeria
- Pipe processing: SAWH
- Grade: APIX70-PSL2
- Dimensions: 1700 x 12.7 mm
- Total volume: 36 kt
- Production plant: Fos-sur-Mer
- Deliveries: 2008-2010

Chevron Escravos offshore pipeline (20")

- Country: Nigeria
- End user: Chevron Nigeria
- Customer: SCC Nigeria, Ltd
- Pipe processing: SAWH
- Grade: APIX52-PSL2
- Dimensions: 1020 x 12.7 mm
- Total volume: 2.5 kt
- Production plant: Fos-sur-Mer
- Deliveries: 2011

Baku-Tbilisi-Ceyhan sour service oil pipeline (34", 40", 42")

- Country: Turkey, Georgia and Azerbaijan
- End user: Saudi ARAMCO
- Customer: Turkish Pipe Consortium
- Pipe processing: SAWH
- Grade: APIX65-PSL2 sour
- Total volume: 130 kt
- Production plant: Fos-sur-Mer

TIGF pipeline (32" and 36")

- Country: France
- End user: TOTAL – TIGF (France)
- Customer: Siderúrgica del Tubo Soldado (Spain)
- Pipe processing: SAWH
- Grades: APIX65 and APIX70-PSL2
- Dimensions: 1300 x 22.5 and 1800 x 14.5 mm
- Total volume: 22 kt
- Production plant: Fos-sur-Mer, Bremen
- Deliveries: 2010

ArcelorMittal Flat Carbon Europe – with mills dedicated to the Oil & Gas Pipe industry in Germany, France

and Poland – serves the global API pipe market together with our divisions in the USA and Brazil.

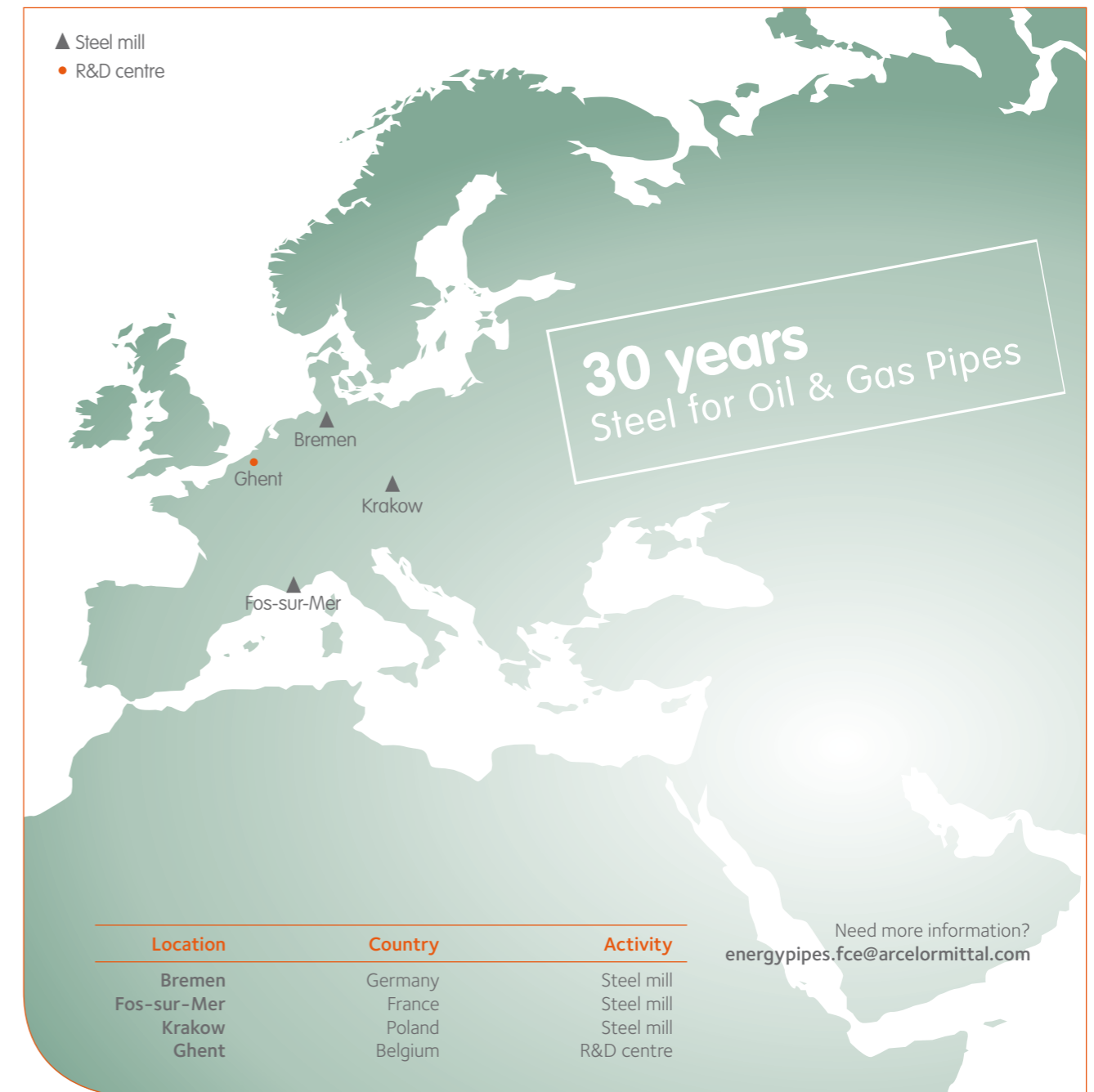

Our Global network

ArcelorMittal Flat Carbon Europe engages a global workforce with local presence in 40 countries with the daily support of ArcelorMittal International.

Our widespread network allows us to provide our customers with the expertise they need it, wherever they may be.



Principal office
ArcelorMittal Flat Carbon Europe
Steel for Oil & Gas Pipes
Aile 9
13776 Fos-sur-Mer (France)
T. +33 442472701
energypipes.fce@arcelormittal.com

Germany
ArcelorMittal FCE Germany
Subbelrather Straße 13
Köln 50672
T. +49(0)2215729360
energypipes.fce@arcelormittal.com

Africa
ArcelorMittal International
Douar Chtaiba, Route 107 - Zenata Mohammedia
Casablanca
Morocco
T. +212-5-22-75 17 25
F. +212-5-22-75 17 43
ami-africa@arcelormittal.com

Belgium
ArcelorMittal International
Antwerp
Atlantic House
Noorderlaan 147
B-2030 Antwerp, Belgium
T. +32 3 2440800
F. +32 3 2386069
ami-antwerp@arcelormittal.com

Brazil
ArcelorMittal International
Alameda Santos 700, 13° andar
CEP 01418-100- SP
Brazil
T. +55 11 36 38 69 02
F. +55 11 36 38 69 00
ami-brazil@arcelormittal.com

Canada
ArcelorMittal International
Inc. Box 2460,
1330 Burlington St.E,
Hamilton, Ontario L8N 3J5, Canada
T. +1-905-634 1400
F. +1-905-634 3536
ami-canada@arcelormittal.com

Chile
ArcelorMittal International
S.A.San Pio X N° 2460 Of. 705.
Providencia/Santiago
Chile
T. +56-2-233 96 94
F. +56-2-233 26 80
ami-chile@arcelormittal.com

China (People's Republic of)
ArcelorMittal International
Beijing
Fortune Plaza Office Tower A, Room 3801
7 Dongsanhuan Zhong Lu Chaoyang District
100020 Beijing
P.R. China
T. +86-10-65309633
F. +86-10-65309884
ami-beijing@arcelormittal.com

Urumqi
8 F China Development Bank Tower
Fountain Plaza, N° 333 Zhang Shang Road Urumqi,
Xinjiang,
P.R. China
T. +86-991 23396 02
F. +86-991 23396 01

Shanghai
Unit A2 -13F Time Square, 500 Zhangyang Road
Pudong, Shanghai 200122
P.R. China
T. +86-21-58368200
F. +86-21-58368107
ami-china@arcelormittal.com

Hong Kong
Room 1601, 16/F, Tower 1, China
Hong Kong City, 33 Canton Road
Tsimshatsui, Kowloon, Hong Kong,
P.R. China
T. +852-2522 4123
F. +852-2521 7905
ami-hongkong@arcelormittal.com

Guangzhou
Unit 05-06, 34th Floor, Info Souce Plaza
No 898 Tian He Bei Road, Tian He Area
510898 Guangzhou,
P.R. China
T. +86 20 3818 2813
F. +86 20 3818 2816

Colombia
ArcelorMittal International
Calle 90 N° 12-45 Of. 605
Santafe De Bogota, Colombia
T. +57-1-623 40 22
F. +57-1-610 01 73
ami-colombia@arcelormittal.com

Ecuador
ArcelorMittal International
Av. Pampite S/N y Chimborazo
Centro Comercial La Esquina, Oficina 3
Cumbayá
Quito, Ecuador
T. +593-2-289 2162 / 2163 / 2164
F. +593-2-289 4071
ami-ecuador@arcelormittal.com

Egypt
ArcelorMittal International
Unit 1 Building no.15
Road no.254
11728 Digla
- Maadi - Cairo, Egypt
Mob. +201 000 90 212
omar.elias@arcelormittal.com

India
ArcelorMittal International
Mumbai
205, Sentinel
Hiranandani Gardens
Powai
Mumbai-400076, India
T. +91 22 4248 9516
F. +91 22 6702 9546
subodh.shinde@arcelormittal.com
ami-india@arcelormittal.com

Indonesia
ArcelorMittal International
Graha Iskandarsyah Building, 6th floor
Jalan Iskandarsyah Raya N° 66C
Kebayoran Baru, Jakarta Selatan
12160, Indonesia
T. +62-21-7278 3706
F. +62-21-7278 3707
ami-indonesia@arcelormittal.com

Korea
ArcelorMittal International
B-613 kolon tripolis 1, Gungok-dong
Bundang-gu, Sungnam city
Kyunggi-do, Post Code 463804
Korea
T. +82-31-715 3242
F. +82-31-715 3243
ami-korea@arcelormittal.com

Luxembourg
Headquarters
ArcelorMittal International
19, avenue de la Liberté
L-2930 Luxembourg
G.D. of Luxembourg
T. +352 4792 1
F. +352 49 07 49
international@arcelormittal.com

Malaysia
ami-malaysia@arcelormittal.com

Mexico
ArcelorMittal International
Calle Privada de los Industriales 110-A
8° Piso Desp. 801-802
Col. Industrial Benito Juárez
Querétaro, Qro. 76100,
Mexico
T. +52-442-218 6872
F. +52-442-218 1400
ami-mexico@arcelormittal.com

Nigeria
ArcelorMittal International
1B Adebayo Doherty street
off Admiralty way
Lekki Phase 1, Lagos, Nigeria
T. +234-1-277-0802
F. +234-1-277-0803

Peru
ArcelorMittal International
Calle Miguel Dasso 134
Oficina 301
Lima 27
Peru
T. +51-1-421 43 64
F. +51-1-463 06 38
ami-peru@arcelormittal.com

Philippines
ArcelorMittal International
4th Fl/Maga Centre
Paseo de Magallanes Commercial
Magallanes Village, Makati City 1200
Philippines
T. +63-2-8539297
F. +63-2-8539296

Russia
ArcelorMittal International
Moscow
Bolshaya Ordynka Street 44, building 4
119 017 Moscow
Russia
T. +7-495-721 15 51
F. +7-495-721 15 55
ami-moscow@arcelormittal.com

Saudi Arabia
ArcelorMittal International
Saudi Arabia Liaison Office
P.O. BOX 4234
Suite-508, Espalya Tower, Hail Street
King Abdullah Road, Jeddah-21491
Kingdom of Saudi Arabia
T. +966 2 6571720
F. +966 2 6571732
ami-dubai@arcelormittal.com

Senegal
ArcelorMittal International
Stèle Mermoz, Immeuble Saphir
BP 25 377 Dakar fann Senegal
T. +221-33-859-76-30
F. +221-33-859-76-58
ami-africa@arcelormittal.com

Singapore
ArcelorMittal International
72, Anson Road
08-01 Anson House
079911 Singapore
Singapore
T. +65 67339033
F. +65 64127482
ami-asia@arcelormittal.com

South Africa
ArcelorMittal International
Commerce Square
Building 3, 2nd Floor
39 Rivonia Road, Sandhurst, Sandton, 2196
Republic of South Africa
T. +27-11-268 2561/ 2
F. +27-11-268 6416
ami-southafrica@arcelormittal.com

Taiwan
ArcelorMittal International
8F-A3; n°502 Jiou Ru 1st Rd.;
San Min Dist., Kaohsiung,
Taiwan Roc
T. +886-7-390 04 25
F. +886-7-390 04 27
ami-taiwan@arcelormittal.com

Thailand
ArcelorMittal International
283/48 (Unit 1005-3), Home
Place Group Office Building,10th floor,
Soi Sukhumvit, 55 Sukhumvit Road, Wattana District
Bangkok 10110,
Thailand
T. +66-2-712 74 35
F. +66-2-712 73 50
ami-thailand@arcelormittal.com

Turkey
ArcelorMittal International
Celik Dis Ticaret,
Nispetiye Cad.,
Ozden Is Merkezi,
N° 22/4 Levent
T-34330 Istanbul,
Turkey
T. +90-212-317 49 00
F. +90-212-283 76 67
rajesh.saigal@arcelormittal.com

Ukraine
ArcelorMittal International
20 Velyka Zhytomirska Str.
Kiev, 01025, Ukraine
T. +38 044 201 4912 / 4913/ 4914
F. +38 044 201 4915
alexander.zverev@arcelormittal.com

United Arab Emirates
ArcelorMittal International
FZE Jazfa LOB 15
Office 525, 5th Floor
Jebel Ali Free Zone
PO Box 262098
Dubai, United Arab Emirates
T. +971-4-881 1662
F. +971-4-881 1663
ami-dubai@arcelormittal.com

United States of America (Principal office)
ArcelorMittal International
North America
1 South Dearborn ,13th floor
Chicago, IL, 60603, USA
T. +1-312-899-3500
F. +1-312-899-3798
ami-america@arcelormittal.com

Houston
ArcelorMittal International
2011 West TC Jester Blvd
Houston TX77008-1254
T. +1-713-880-4100
F. +1-713-880-4277

Venezuela
ArcelorMittal International
Edificio Keope, Avenida Vera Cruz, Piso 4, Oficina 45-A
Las Mercedes/Caracas 1060 A,
Venezuela
T. +58-212-993 46 35 / 993 81 01 / 991 41 97
F. +58-212-992 13 42
ami-venezuela@arcelormittal.com

Vietnam
ArcelorMittal International
D35, 40 Ba Huyen Thanh Quan, Ward 6,
Dist. 3, Ho Chi Minh City,
Vietnam
T. +84-8-9307248
F. +84-8-9307246
ami-vietnam@arcelormittal.com

Copyright
All rights reserved. No part of this publication may be reproduced in any form or by any means whatsoever, without prior written permission from ArcelorMittal. Care has been taken to ensure that the information in this publication is accurate, but this information is not contractual. Therefore ArcelorMittal and any other ArcelorMittal Group company do not accept any liability for errors or omissions or any information that is found to be misleading. As this document may be subject to change at any time, please consult the latest information in the product document centre at www.arcelormittal.com/industry